

Please take time to read and follow the instruction below.

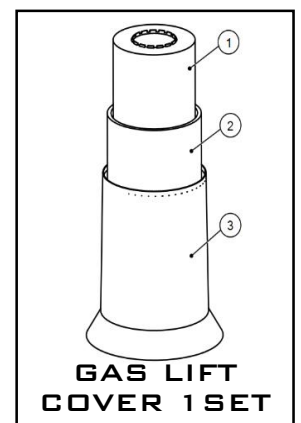
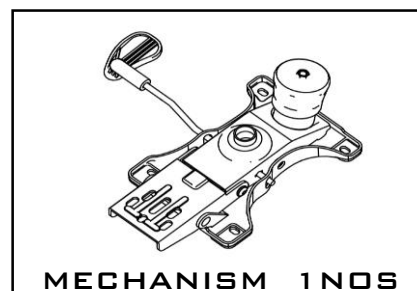
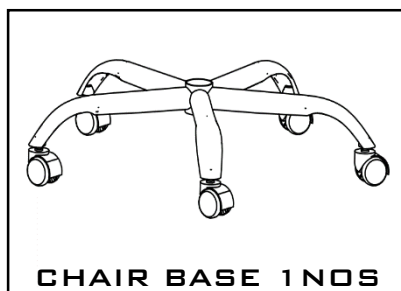
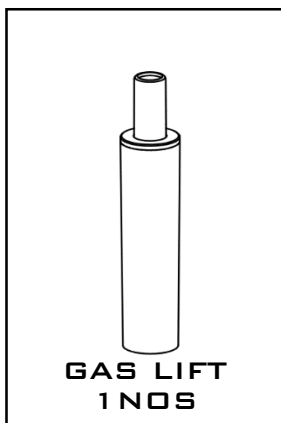
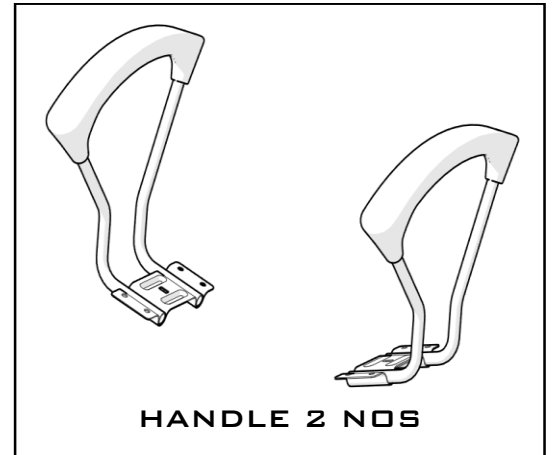
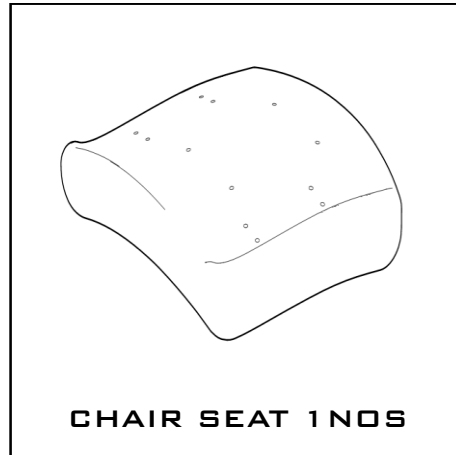

Attention:

- Check that you have all parts and hardware before assembly.
- Parts apparently missing are often found in the packaging material.
- Hardware are already fitted into component.
- Use sticker as a reference for easy assembly.
- Do not tighten screw fully until you have completed assembly.
- Do not use this product unless all bolts are firmly secured.
- Check that all bolts and screws are securely tightened at least every 4 months.

Step 1

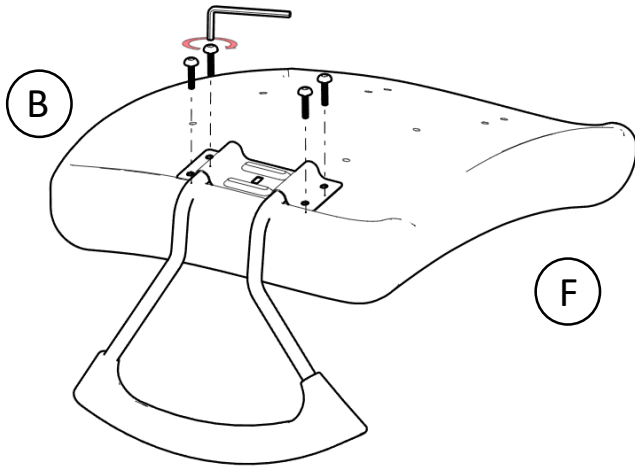

Match the sticker before fitting

Place seat as shown in image
than fit Handle

Repeat step 1 for fitting other side of handle.

Step 2

Place the seat as shown in image

Put mechanism on it same as in image than fit it.

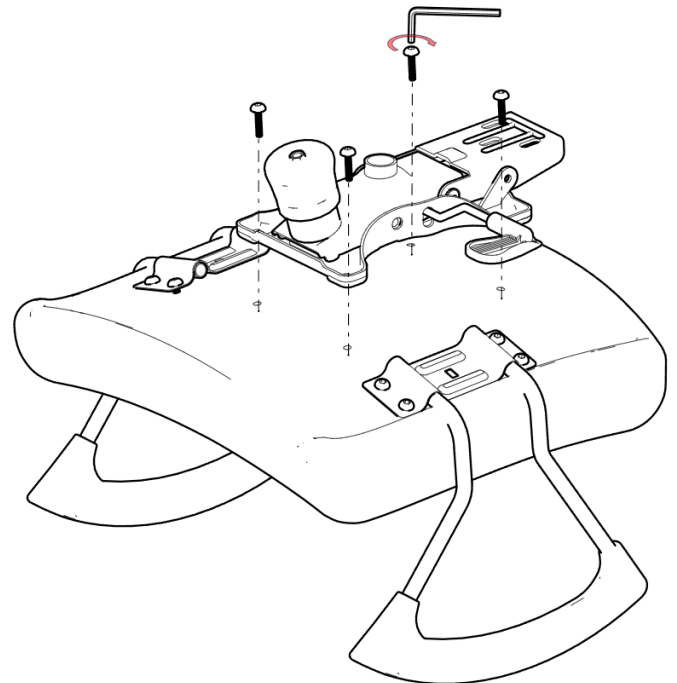

Make sure direction of arrow on mechanism is
toward the seat front

Step 3

Apply grease sponge on back side of the seat at shaded area as shown in image.

(Note: Don't forgot the step before fit a chair back)

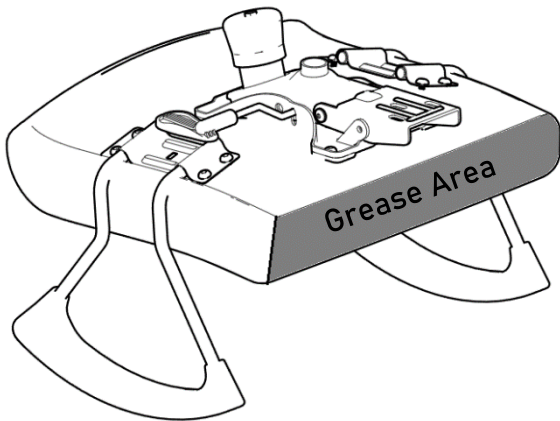

Step 4

Fix the chair back with the mechanism as shown in image

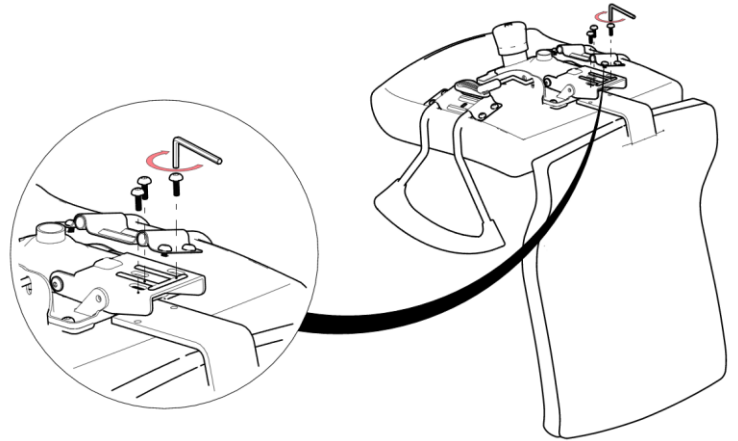

Step 5

Place the chair base on floor

Cover the gas lift with the gas lift cover and fix it to the chair base

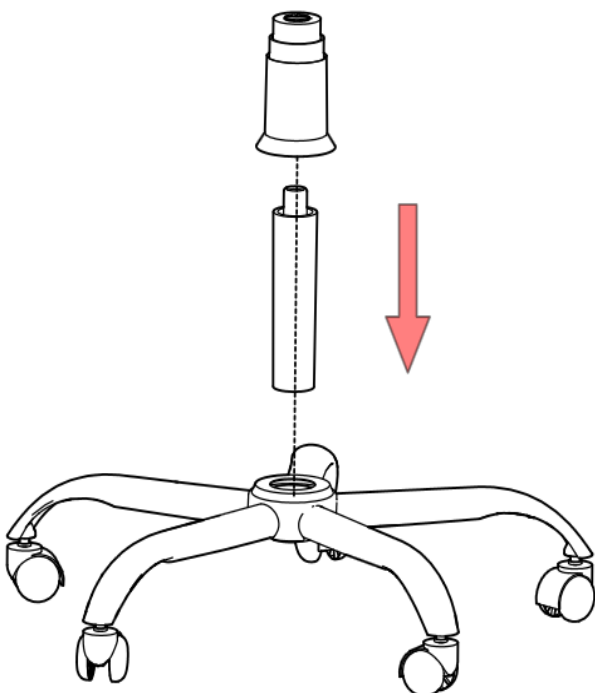

Step 6

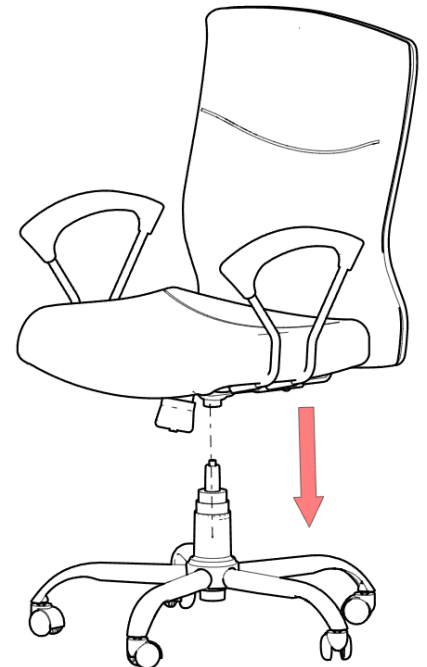

Attach the seat and back assembly of chair to the base assembly

(Note: Check the chair to ensure proper fixing)

ASSEMBLY MANUAL



Contact us: +91-9904304466
10:00 AM to 5:30 PM (Monday-Friday)
shop.hofindia.com

Model: Z-401