

Please take time to read and follow the instruction below.

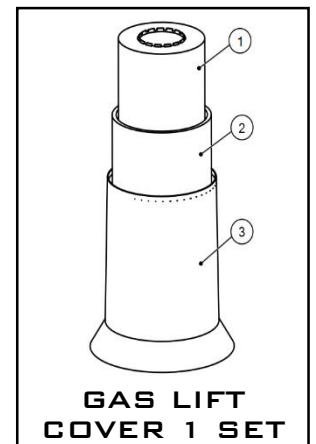
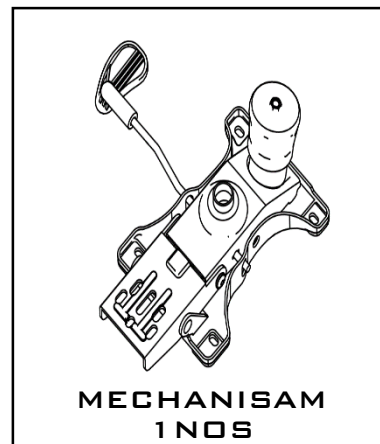
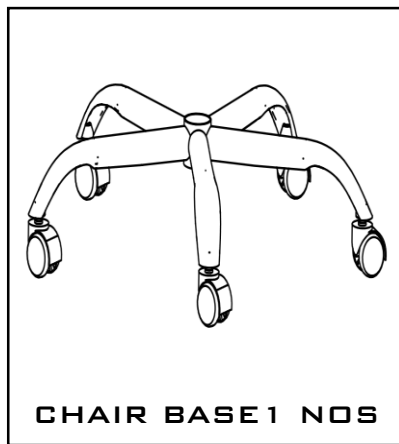
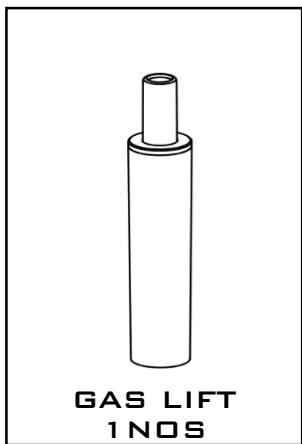
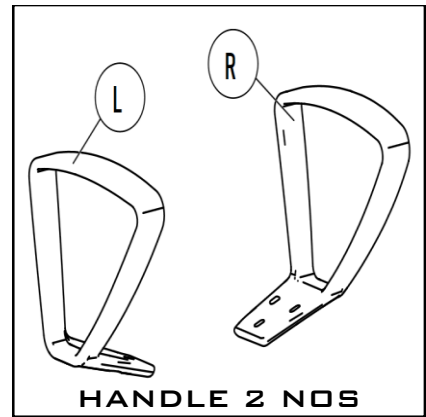
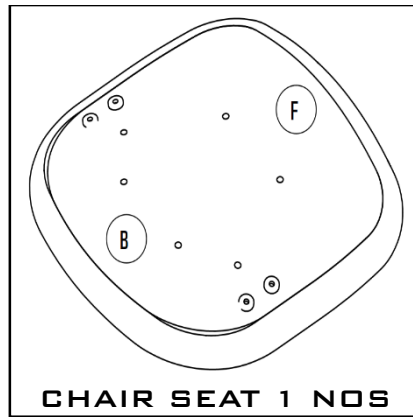

Attention:

- Check that you have all parts and hardware before assembly.
- Parts apparently missing are often found in the packaging material.
- Hardware are already fitted into component.
- Use sticker as a reference for easy assembly.
- Do not tighten screw fully until you have completed assembly.
- Do not use this product unless all bolts are firmly secured.
- Check that all bolts and screws are securely tightened at least every 4 months.

Step 1

Place seat as shown in image than fit mechanism
(Note: focus on right bottom corner annotation F-front
B-back)

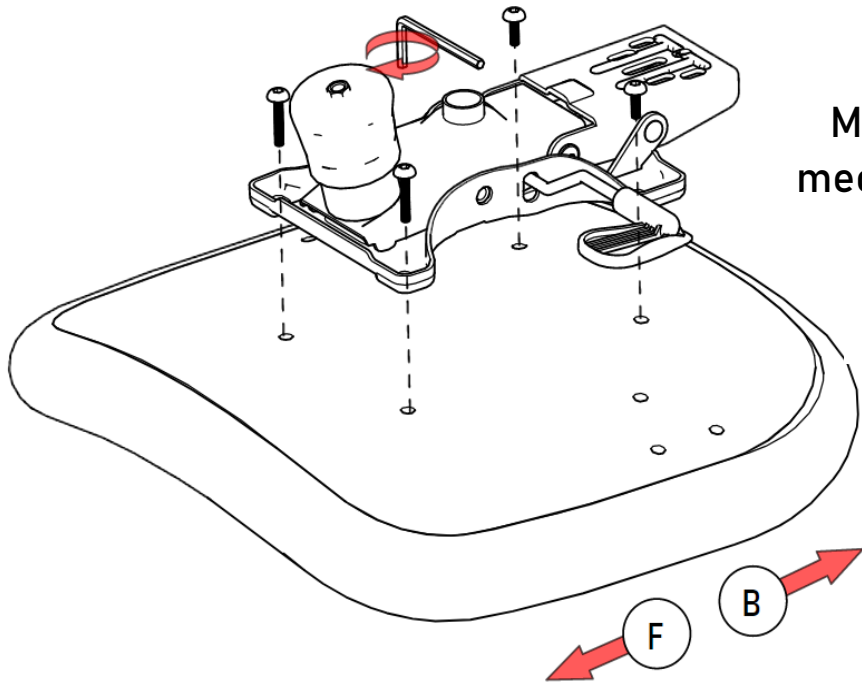

Make sure direction of arrow on
mechanism is toward the seat front

Match the sticker before fitting

Step 2

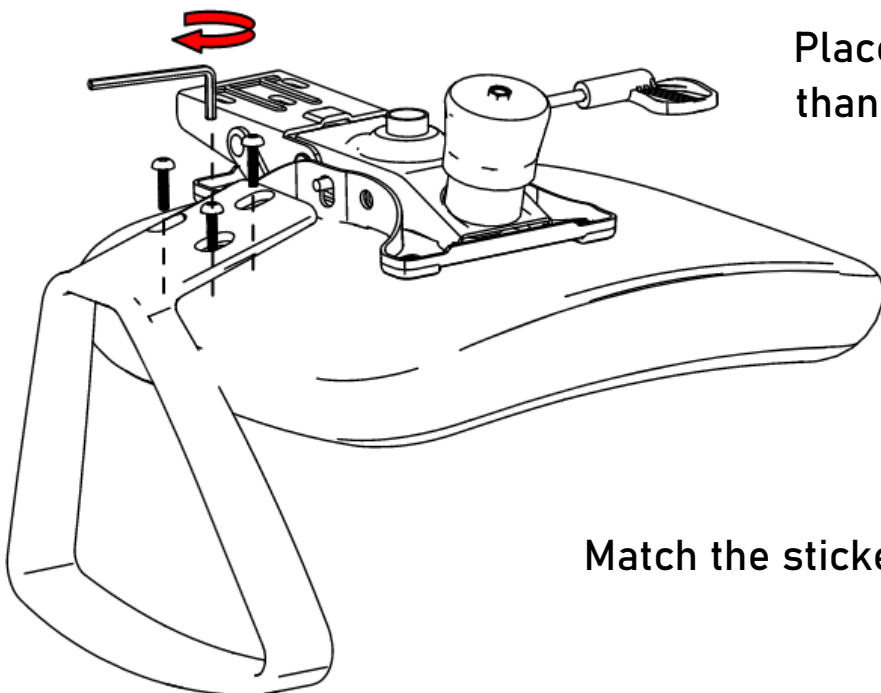

Place the handle as shown in image
than fit with the help of Allen screw
and Allen key

Match the sticker before fitting

Step 2 follow for fitting other side of handle

Step 3

Fix the chair back with the mechanism as shown in image

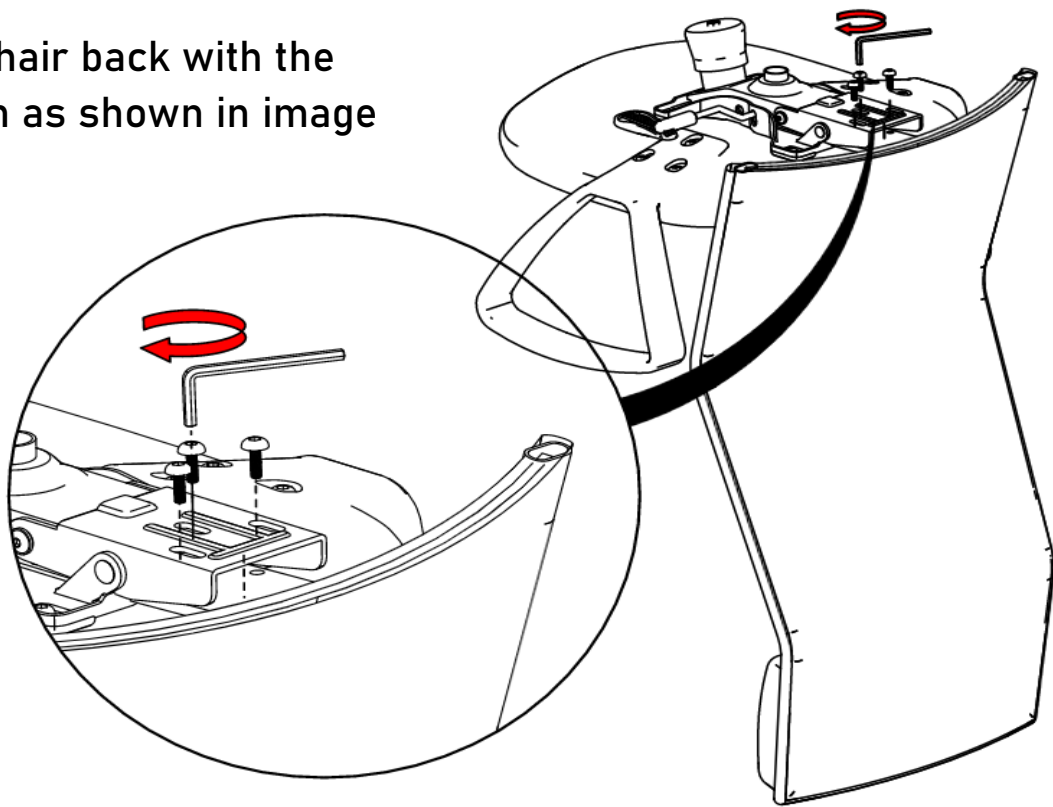

Step 4

Place the chair base on floor
Cover the gas lift with the gas lift cover
and fix it to the chair base

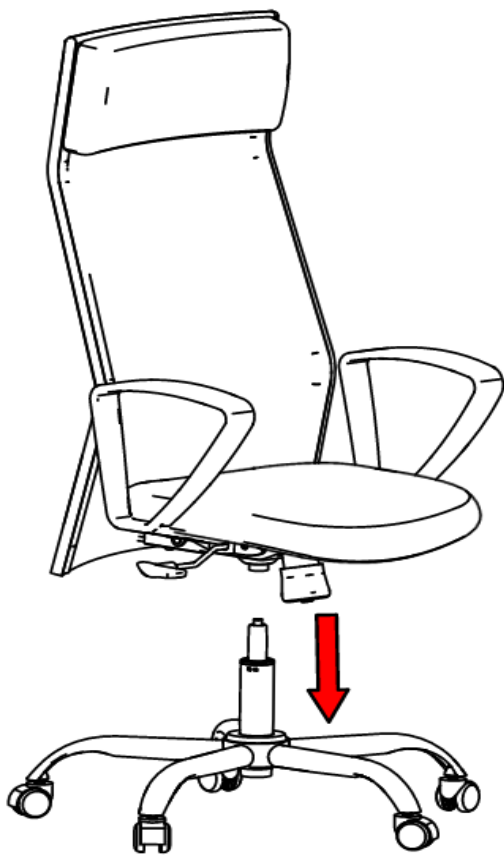

Attach the seat and back assembly
of chair to the base assembly
(Note: Check the chair to ensure
proper fixing)

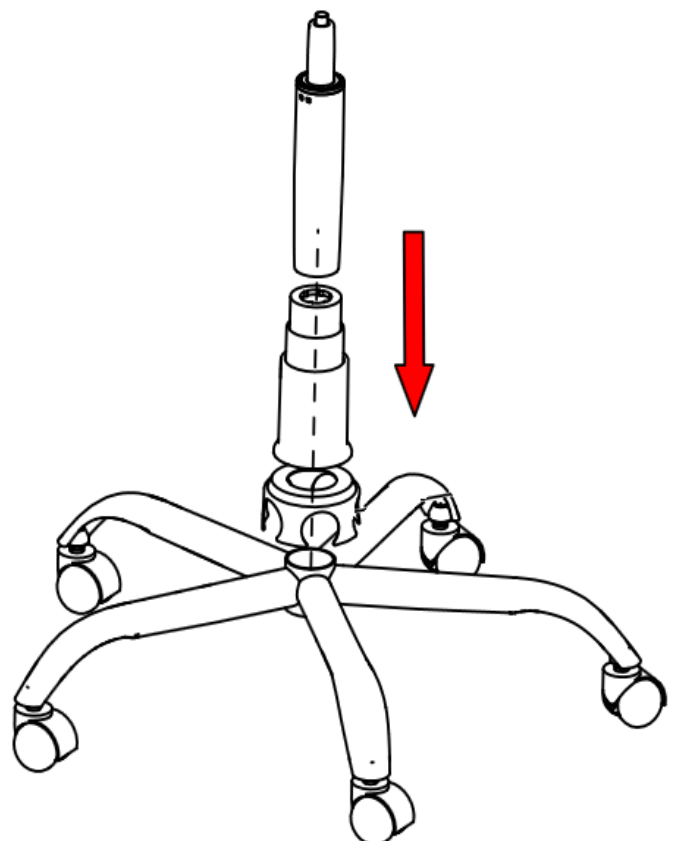



Scan the QR Code for watching
chair assembly instruction video



ASSEMBLY MANUAL



Contact us: +91-9904304466
10:00 AM to 5:30 PM (Monday-Friday)
shop.hofindia.com

Model: F-511